



PARALYMPIC GAMES LONDON 2012

30/08/2012



F-48

Nb=8

A

- B1 POTAPOVA Viktor RUS
- B2 BRUSSIG Carmen GER
- B2 GARCIA BENITEZ ESP
- B2 HALINSKA Yuliya UKR

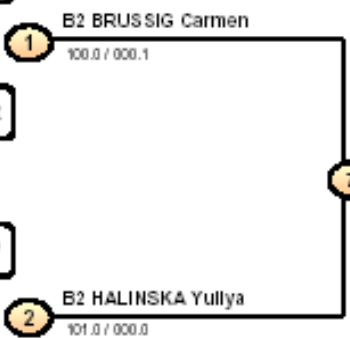

B

- B2 HUANG Xiaoli CHN
- B3 FERREIRA CARDOS BRA
- B2 LEE Kai Lin TPE
- B2 LACLAU Solene FRA

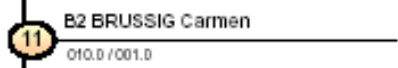
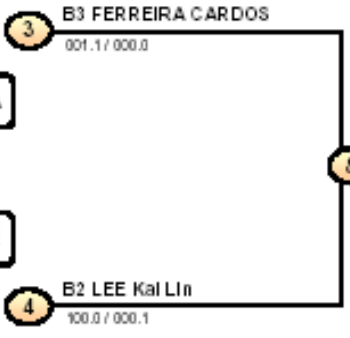

REPECHAGE

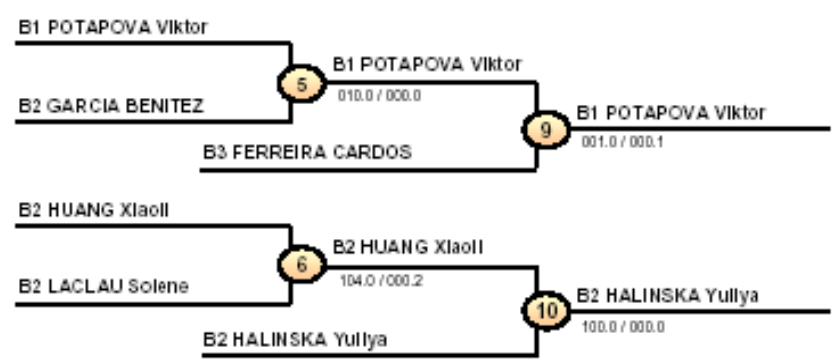

1-	B2 BRUSSIG Carmen	GER
2-	B2 LEE Kai Lin	TPE
3-	B1 POTAPOVA Viktor	RUS
3-	B2 HALINSKA Yuliya	UKR
5-	B3 FERREIRA CARDOS	BRA
5-	B2 HUANG Xiaoli	CHN
7-	B2 GARCIA BENITEZ	ESP
7-	B2 LACLAU Solene	FRA





PARALYMPIC GAMES LONDON 2012

30/08/2012



F-52

Nb=8

A

- B2 NIKOLAYCHYK Nat UKR
- B2 MARTINET Sandri FRA
- B3 HANGAI Shizuka JPN
- B2 WANG Lijing CHN

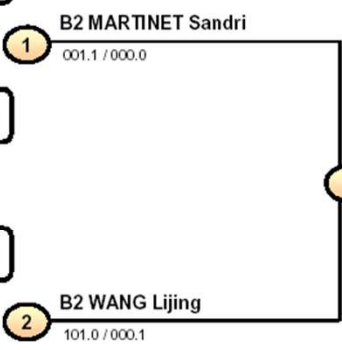

B

- B3 BRUSSIG Ramona GER
- B2 KILIC Gulhan TUR
- B2 STEPANIUK Alesi RUS
- B2 FERREIRA Michel BRA

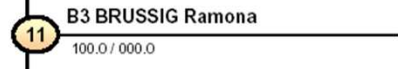
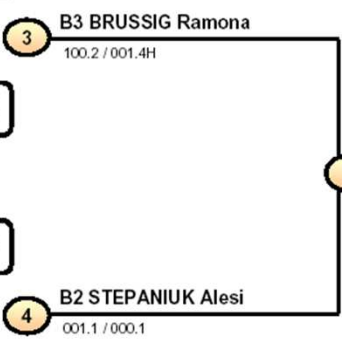

REPECHAGE

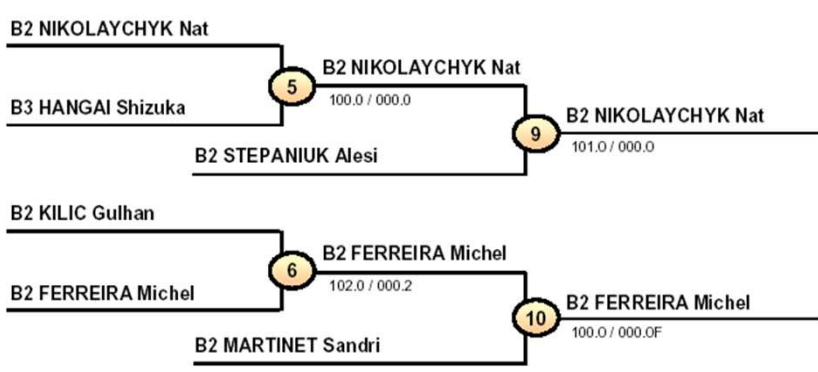

1-		B3 BRUSSIG Ramona	GER
2-		B2 WANG Lijing	CHN
3-		B2 NIKOLAYCHYK Nat	UKR
3-		B2 FERREIRA Michel	BRA
5-		B2 STEPANIUK Alesi	RUS
5-		B2 MARTINET Sandri	FRA
7-		B3 HANGAI Shizuka	JPN
7-		B2 KILIC Gulhan	TUR





PARALYMPIC GAMES LONDON 2012

30/08/2012



M-60

Nb=12

A

B3 KARN Justin	CAN	1	B2 HIRAI Takaaki	100.0 / 000.0
B2 HIRAI Takaaki	JPN	1		
B3 CASTELLANOS COR	COL	2	B3 CASTELLANOS COR	
		2		
B2 LEE Min Jae	KOR	3	B2 IBRAHIMOV Ramin	101.0 / 000.0
B2 IBRAHIMOV Ramin	AZE	3		
B3 VILLEMONT Kevin	FRA	4	B3 VILLEMONT Kevin	
		4		

9 B2 HIRAI Takaaki
101.0 / 000.1

19 B2 IBRAHIMOV Ramin
110.1 / 000.0

10 B2 IBRAHIMOV Ramin
100.0 / 000.1

23 B2 IBRAHIMOV Ramin
101.1 / 000.0

B

		5	B1 LI Xiaodong	
B1 LI Xiaodong	CHN	5		
B1 ZASYADKOYCH Ih	UKR	6	B2 HAWTHORNE Ron	101.0 / 010.1
B2 HAWTHORNE Ron	USA	6		
		7	B3 QUILTER Ben	
B3 QUILTER Ben	GBR	7		
B3 NOURA Mouloud	ALG	8	B3 NOURA Mouloud	100.1 / 000.1
B3 AAJIM Mukhbat	MGL	8		

11 B1 LI Xiaodong
100.0 / 000.0

20 B1 LI Xiaodong
100.0 / 000.0

12 B3 NOURA Mouloud
102.1 / 000.0

1-	B2 IBRAHIMOV Ramin	AZE
2-	B1 LI Xiaodong	CHN
3-	B3 QUILTER Ben	GBR
3-	B3 NOURA Mouloud	ALG
5-	B2 HIRAI Takaaki	JPN
5-	B2 LEE Min Jae	KOR
7-	B3 KARN Justin	CAN
7-	B2 HAWTHORNE Ron	USA

REPECHAGE A

B3 KARN Justin		13	B3 KARN Justin	101.0 / 000.2
B3 CASTELLANOS COR		13		
B2 LEE Min Jae		14	B2 LEE Min Jae	100.0 / 000.1
B3 VILLEMONT Kevin		14		
		17	B2 LEE Min Jae	100.0 / 000.4H
		17	B3 NOURA Mouloud	

22 B3 NOURA Mouloud
110.0 / 001.1

REPECHAGE B

B2 HAWTHORNE Ron		15	B2 HAWTHORNE Ron	000.0D / 000.0
B2 HAWTHORNE Ron		15		
B3 AAJIM Mukhbat		16	B3 QUILTER Ben	100.0 / 000.0
B3 QUILTER Ben		16		
		18	B3 QUILTER Ben	102.0 / 000.1
		18	B2 HIRAI Takaaki	

21 B3 QUILTER Ben
100.0 / 000.0





PARALYMPIC GAMES LONDON 2012

30/08/2012



M-66

Nb=10

A

- 1 B2 ZHAO Xu CHN
- 2 B3 MUSTAFAYEV Bay AZE
- 3 B1 RUDENKO Victor RUS
- 4 B2 HIROSE Makoto JPN
- 5 B3 LAMRI Sid Ali ALG

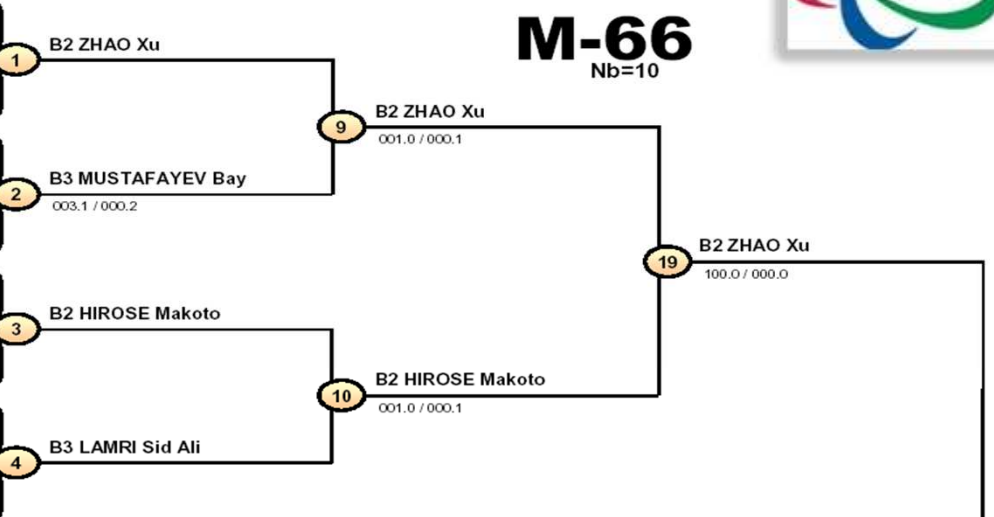

B

- 6 B2 GARCIA DEL VALL ESP
- 7 B3 RAHMATI Saeid IRI
- 8 B2 FALCON Marcos VEN
- 9 B2 KHORAVA Davydd UKR
- 10 ~~KALLUNKI~~

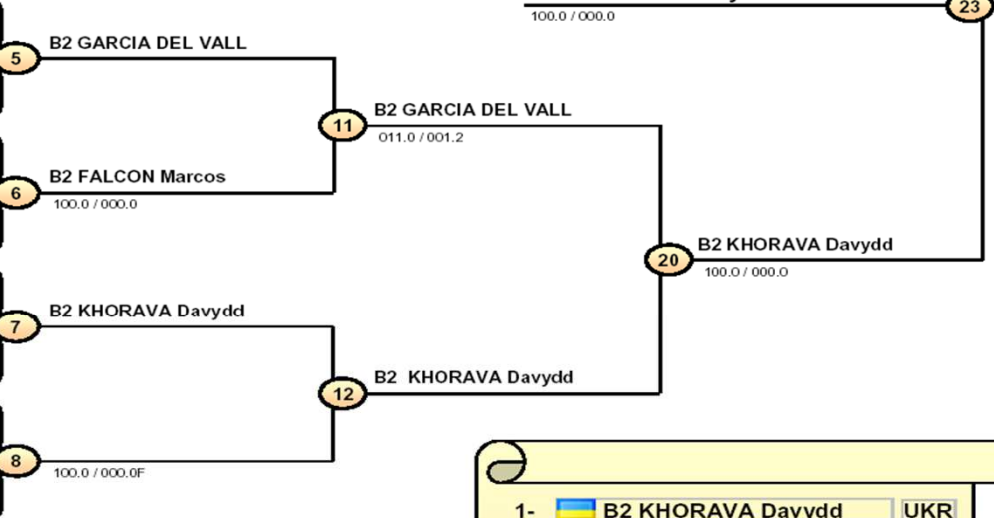

1-		B2 KHORAVA Davydd	UKR
2-		B2 ZHAO Xu	CHN
3-		B2 FALCON Marcos	VEN
3-		B3 LAMRI Sid Ali	ALG
5-		B2 HIROSE Makoto	JPN
5-		B2 GARCIA DEL VALL	ESP
7-		B3 MUSTAFAYEV Bay	AZE
7-			

REPECHAGE A

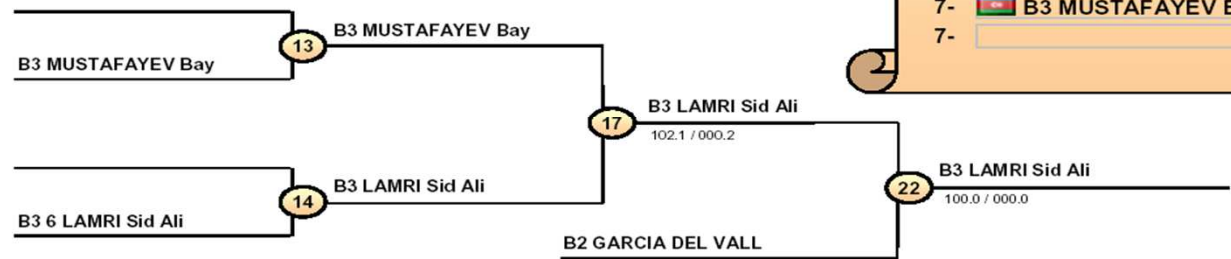

REPECHAGE B

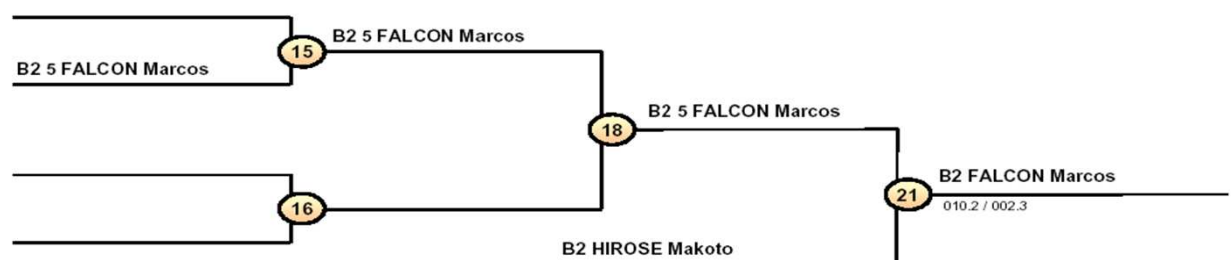



PARALYMPIC GAMES LONDON 2012

31/08/2012



F-57

Nb=7

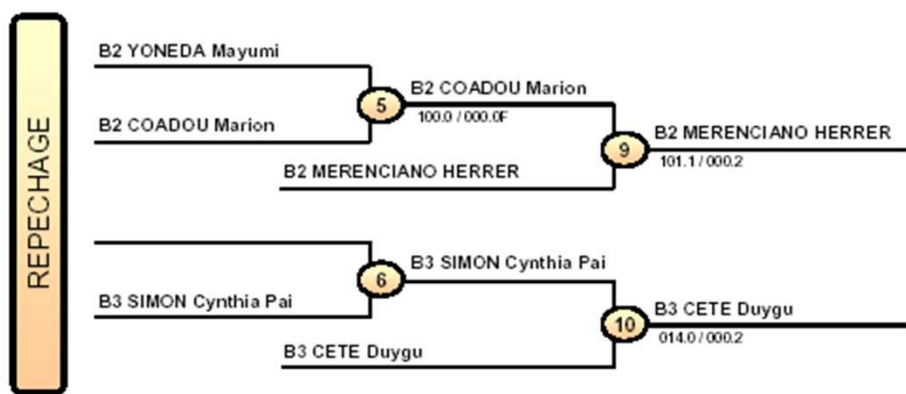
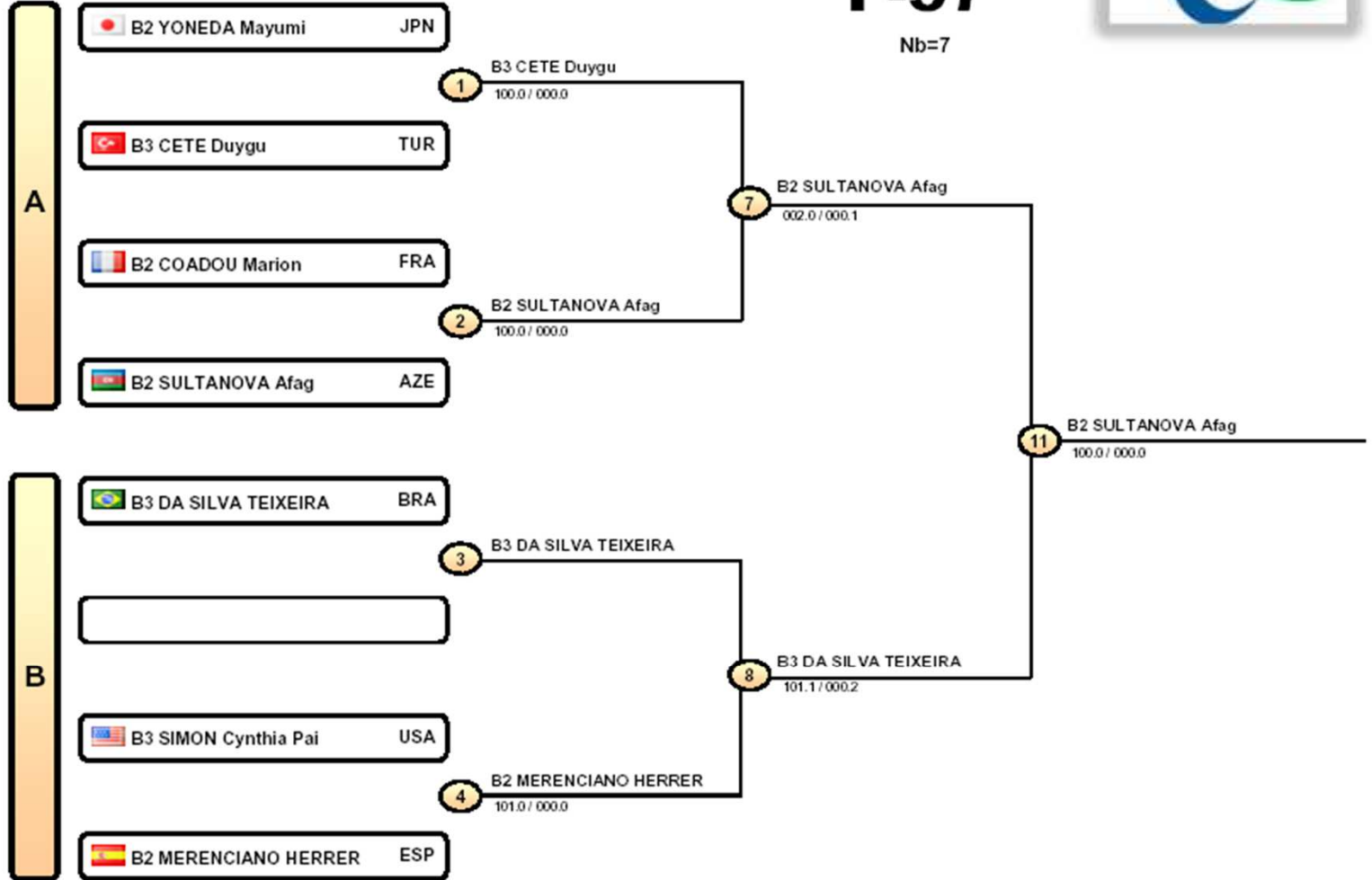

1-		B2 SULTANOVA Afag	AZE
2-		B3 DA SILVA TEIXEIRA	BRA
3-		B2 MERENCIANO HERRE	ESP
3-		B3 CETE Duygu	TUR
5-		B2 COADOU Marion	FRA
5-		B3 SIMON Cynthia Pa	USA
7-		B2 8 YONEDA Mayumi	JPN
7-			





PARALYMPIC GAMES LONDON 2012

31/08/2012



F-63

Nb=8

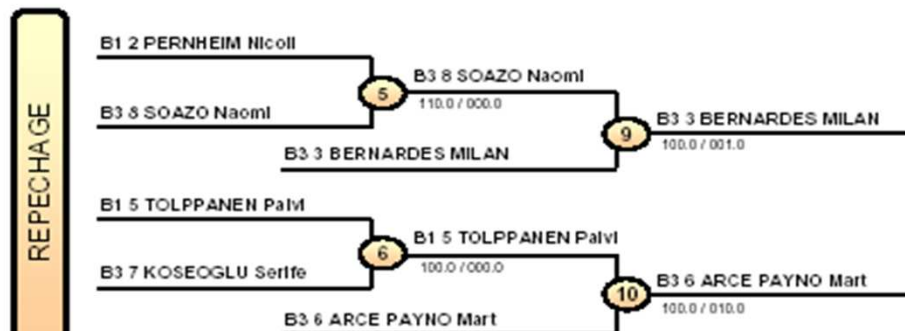
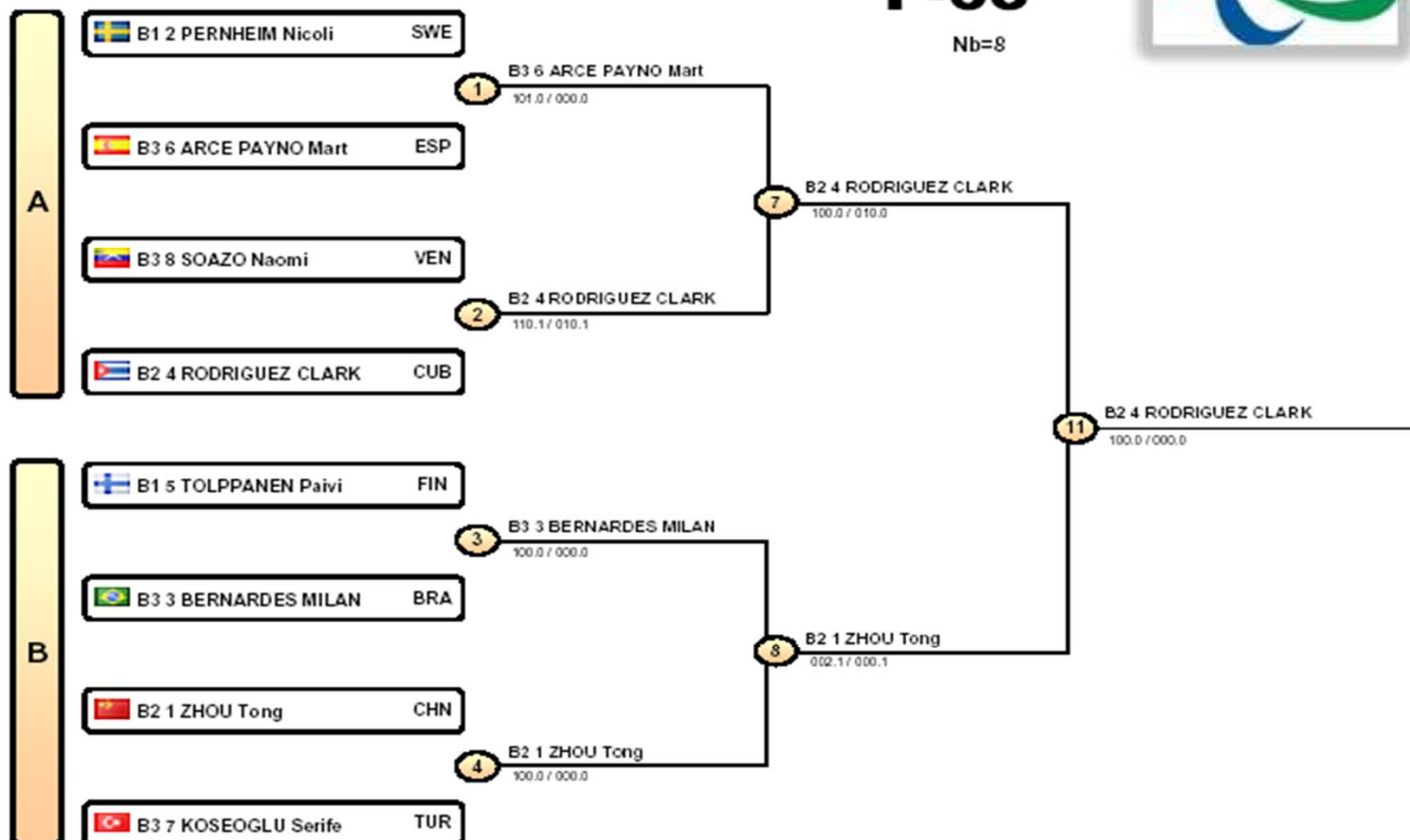

- | | | | |
|----|--|----------------------|-----|
| 1- | | B2 4 RODRIGUEZ CLARK | CUB |
| 2- | | B2 1 ZHOU Tong | CHN |
| 3- | | B3 3 BERNARDES MILAN | BRA |
| 3- | | B3 6 ARCE PAYNO Mart | ESP |
| 5- | | B3 8 SOAZO Naomi | VEN |
| 5- | | B1 5 TOLPPANEN Paivi | FIN |
| 7- | | B1 2 PERNHEIM Nicoli | SWE |
| 7- | | B3 7 KOSEOGLU Serife | TUR |





PARALYMPIC GAMES LONDON 2012

31/08/2012



M-73
Nb=12

A

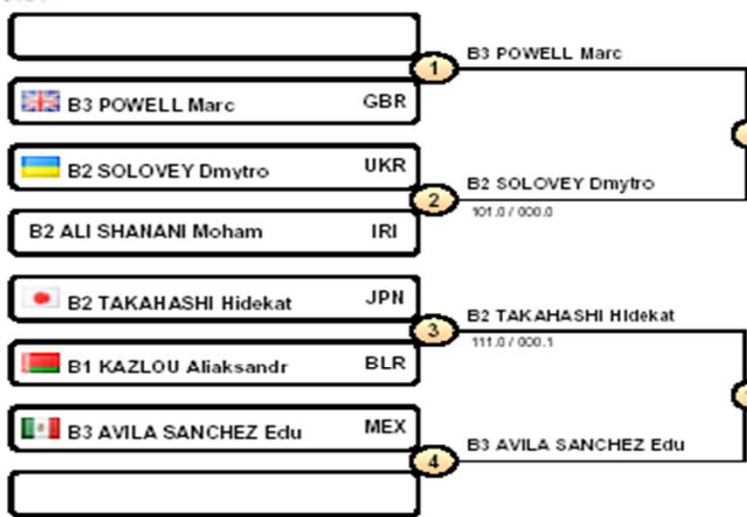

B

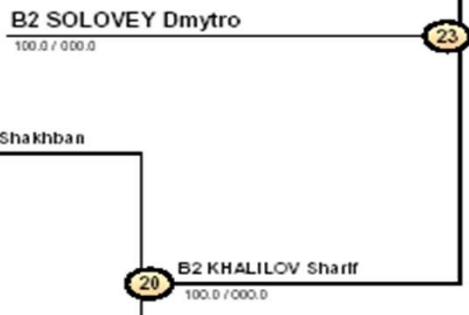
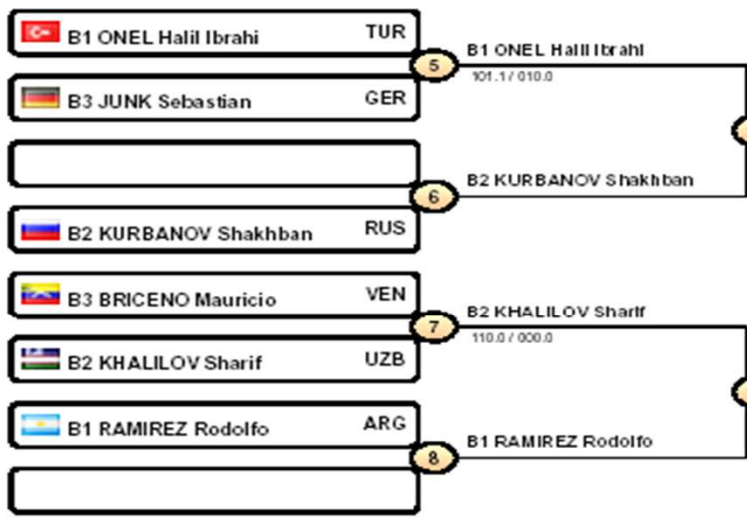

1-		B2 SOLOVEY Dmytro	UKR
2-		B2 KHALILOV Sharif	UZB
3-		B3 AVILA SANCHEZ Edu	MEX
3-		B2 KURBANOV Shakhban	RUS
5-		B3 BRICENO Mauricio	VEN
5-		B2 TAKAHASHI Hidekat	JPN
7-		B2 5 ALI SHANANI Moh	IRI
7-		B1 7 ONEL Halil Ibra	TUR

REPECHAGE A



REPECHAGE B

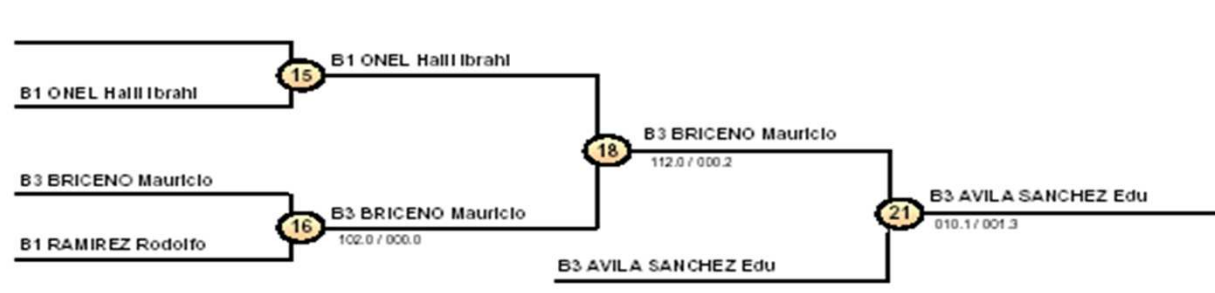



PARALYMPIC GAMES LONDON 2012

31/08/2012



M-81

Nb=12

A

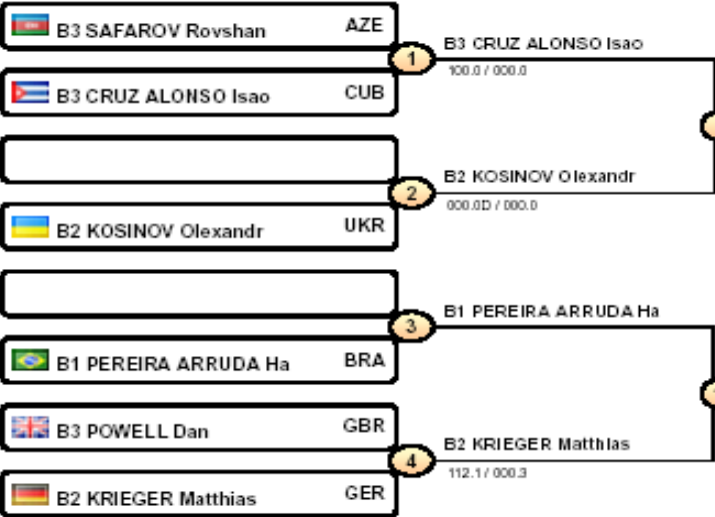

B

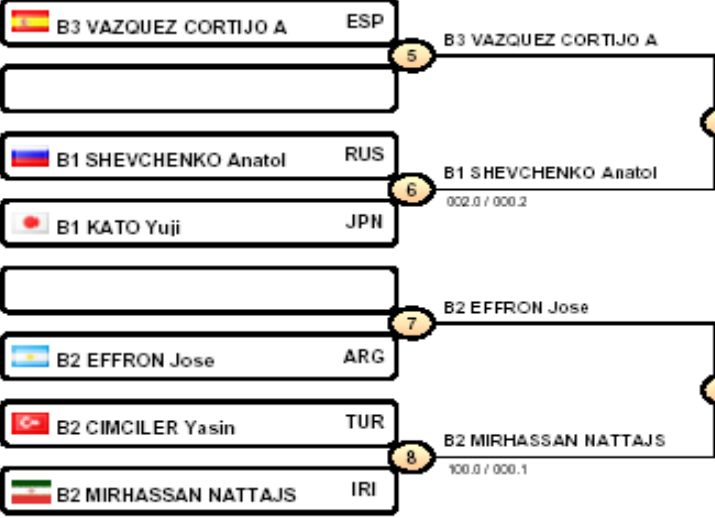

B2 KOSINOV Olexandr
012.2 / 011.2

- | | | | |
|----|--|----------------------|-----|
| 1- | | B2 KOSINOV Olexandr | UKR |
| 2- | | B2 EFFRON Jose | ARG |
| 3- | | B2 KRIEGER Matthias | GER |
| 3- | | B3 CRUZ ALONSO Isao | CUB |
| 5- | | B1 SHEVCHENKO Anatol | RUS |
| 5- | | B3 VAZQUEZ CORTIJO A | ESP |
| 7- | | B3 POWELL Dan | GBR |
| 7- | | B2 MIRHASSAN NATTAJS | IRI |

REPECHAGE A

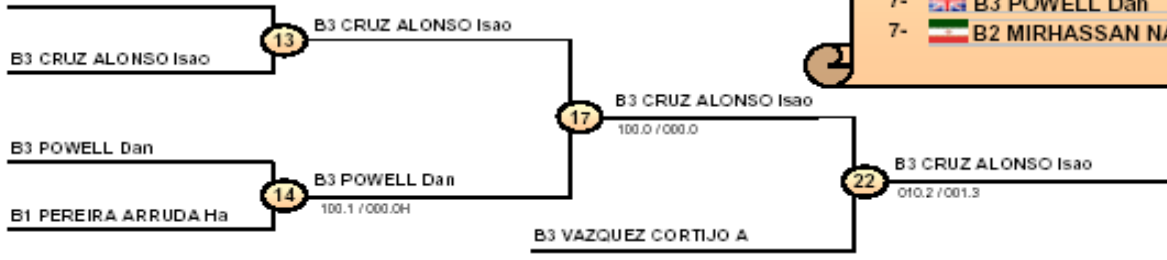

REPECHAGE B

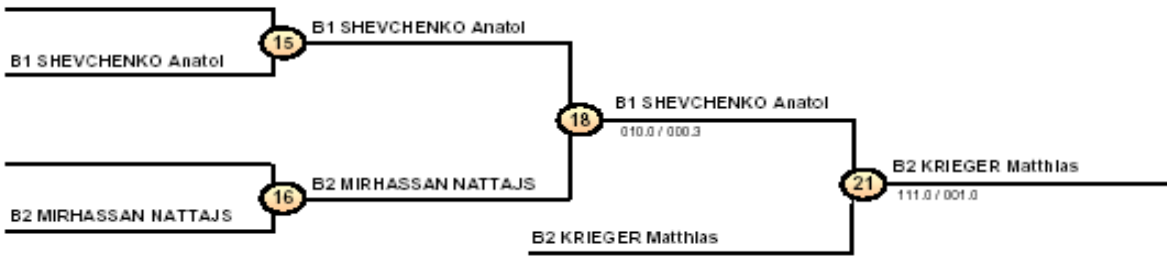



PARALYMPIC GAMES LONDON 2012

01/09/2012



F-70

Nb=7

A

- B3 KACHAN Arina BLR
- B2 SZABO Nikolett HUN
- B2 SAVOSTYANOVA Tati RUS



B

- B3 ZHOU Qian CHN
- B1 GARCIA Christella USA
- B3 HERRERA GOMEZ Mar ESP
- B3 RUVALCABA Lenia MEX

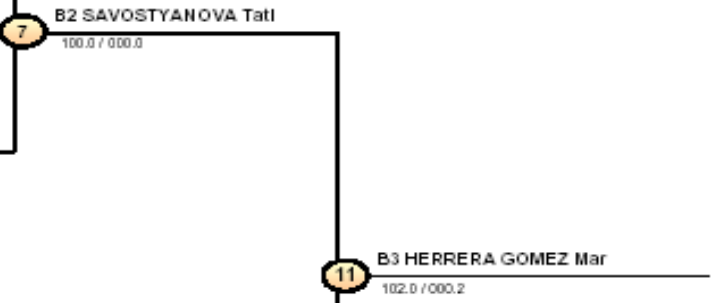
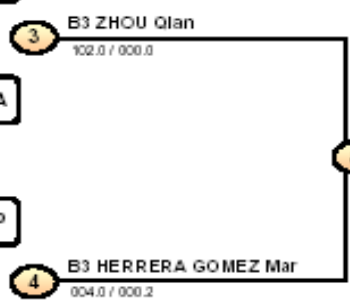

REPECHAGE

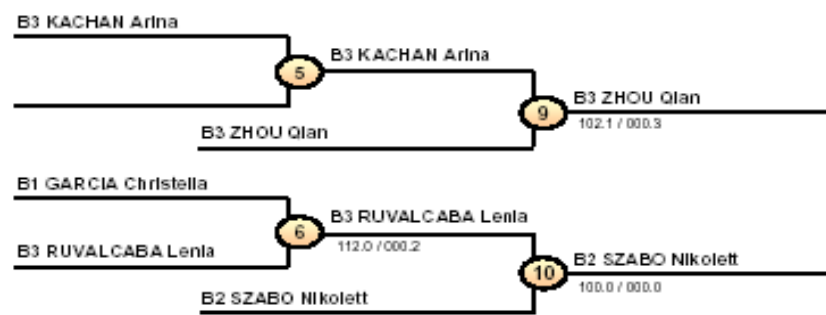

1-		B3 HERRERA GOMEZ Mar	ESP
2-		B2 SAVOSTYANOVA Tati	RUS
3-		B3 ZHOU Qian	CHN
3-		B2 SZABO Nikolett	HUN
5-		B3 KACHAN Arina	BLR
5-		B3 RUVALCABA Lenia	MEX
7-		B1 GARCIA Christella	USA
7-			





PARALYMPIC GAMES LONDON 2012

01/09/2012



F+70

Nb=8

A

B2 YUAN Yanping CHN

B3 BOUAZOUG Zoubida ALG

B1 DAVIS Katie USA

B2 SILVA DE ALMEIDA BRA

1 B2 YUAN Yanping
100.0 / 000.0

2 B2 SILVA DE ALMEIDA
012.2 / 001.0

7 B2 YUAN Yanping
101.0 / 000.0

11 B2 YUAN Yanping
100.0 / 000.0

B

B2 AKIN Nazan TUR

B1 MIHAYLOVA Ivomira BUL

B2 MANZUOLI Céline FRA

B2 KALYANOVA Irina RUS

3 B2 AKIN Nazan
103.0 / 000.4H

4 B2 MANZUOLI Céline
101.0 / 000.0

8 B2 AKIN Nazan
100.0 / 000.0

REPECHAGE

B3 BOUAZOUG Zoubida

B1 DAVIS Katie

B1 MIHAYLOVA Ivomira

B2 KALYANOVA Irina

5 B3 BOUAZOUG Zoubida
100.0 / 000.0

B2 MANZUOLI Céline

6 B2 KALYANOVA Irina
100.0 / 000.1

B2 SILVA DE ALMEIDA

9 B3 BOUAZOUG Zoubida
103.0 / 000.3

10 B2 KALYANOVA Irina
101.2 / 011.3

1-		B2 YUAN Yanping	CHN
2-		B2 AKIN Nazan	TUR
3-		B3 BOUAZOUG Zoubida	ALG
3-		B2 KALYANOVA Irina	RUS
5-		B2 MANZUOLI Céline	FRA
5-		B2 SILVA DE ALMEIDA	BRA
7-		B1 DAVIS Katie	USA
7-		B1 MIHAYLOVA Ivomira	BUL





PARALYMPIC GAMES LONDON 2012

01/09/2012



M-90

Nb=12

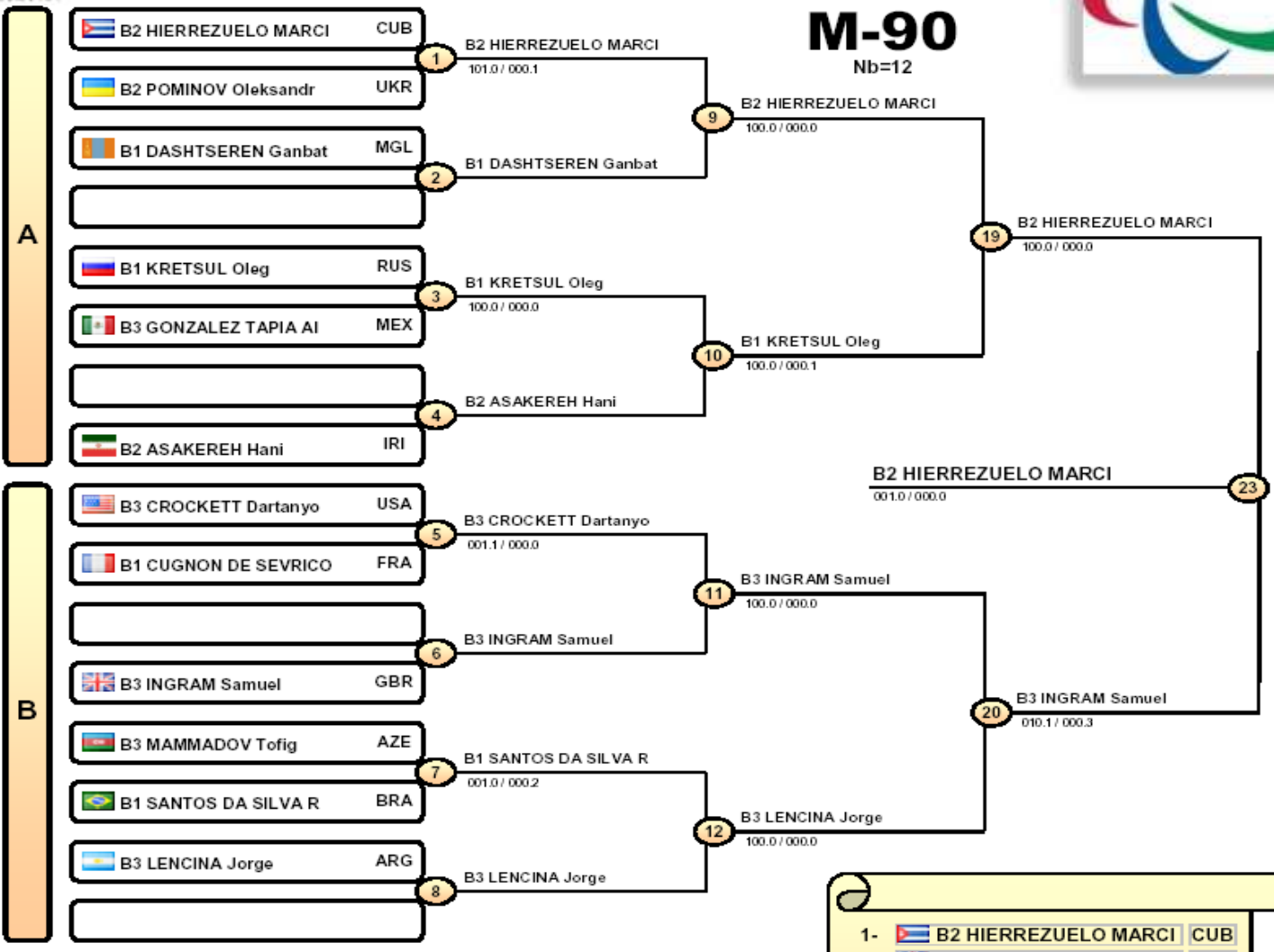

1-		B2 HIERREZUELO MARCI	CUB
2-		B3 INGRAM Samuel	GBR
3-		B3 CROCKETT Dartanyo	USA
3-		B3 LENCINA Jorge	ARG
5-		B1 KRETSUL Oleg	RUS
5-		B2 ASAKEREH Hani	IRI
7-		B1 DASHTSEREN Ganbat	MGL
7-		B1 SANTOS DA SILVA R	BRA

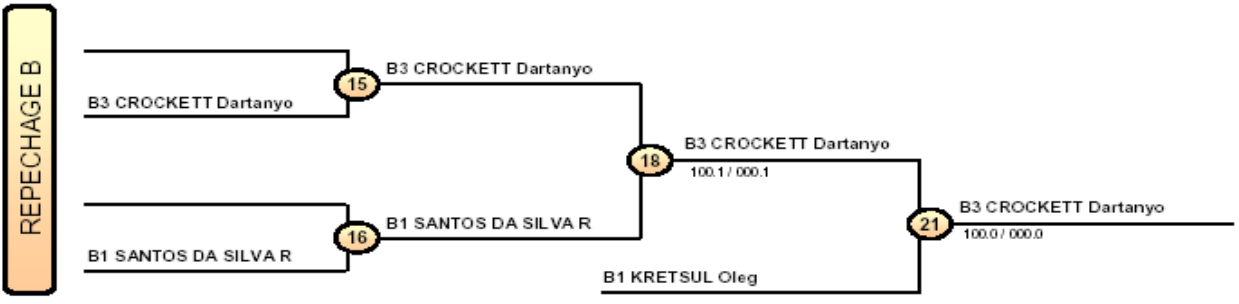
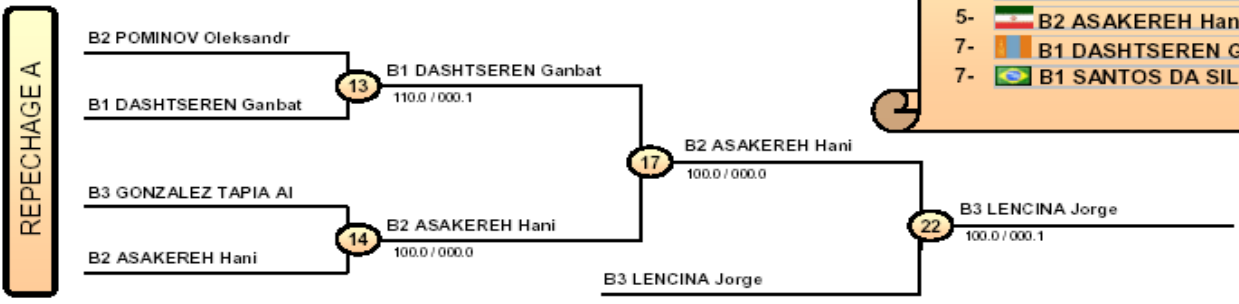



PARALYMPIC GAMES LONDON 2012

01/09/2012 08:21



M-100

Nb=12

A

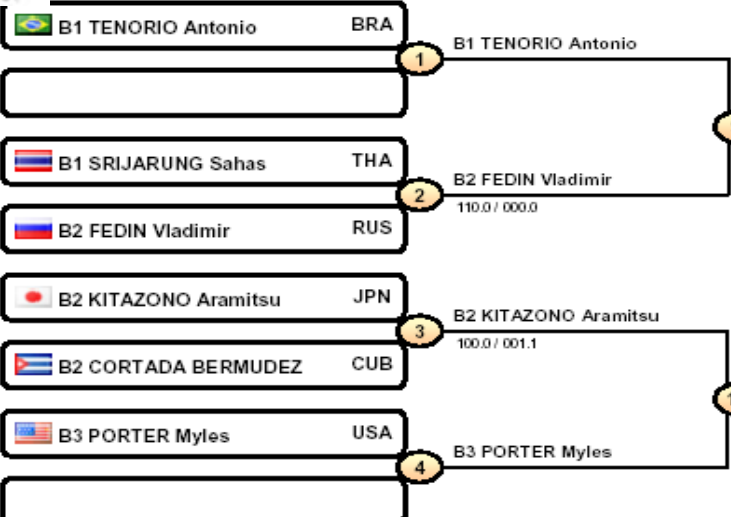

B

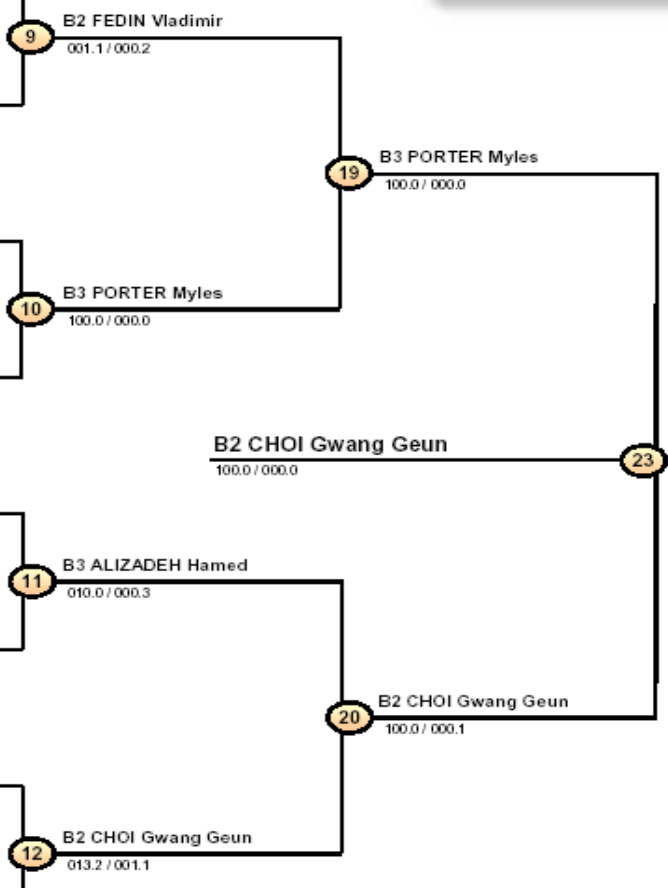
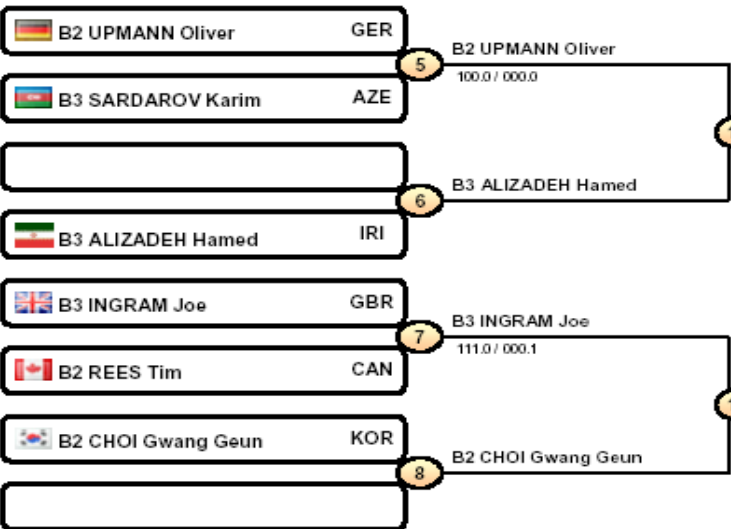

1-		B2 CHOI Gwang Geun	KOR
2-		B3 PORTER Myles	USA
3-		B2 FEDIN Vladimir	RUS
3-		B1 TENORIO Antonio	BRA
5-		B2 UPMANN Oliver	GER
5-		B3 ALIZADEH Hamed	IRI
7-		B2 KITAZONO Aramitsu	JPN
7-		B3 INGRAM Joe	GBR

REPECHAGE A

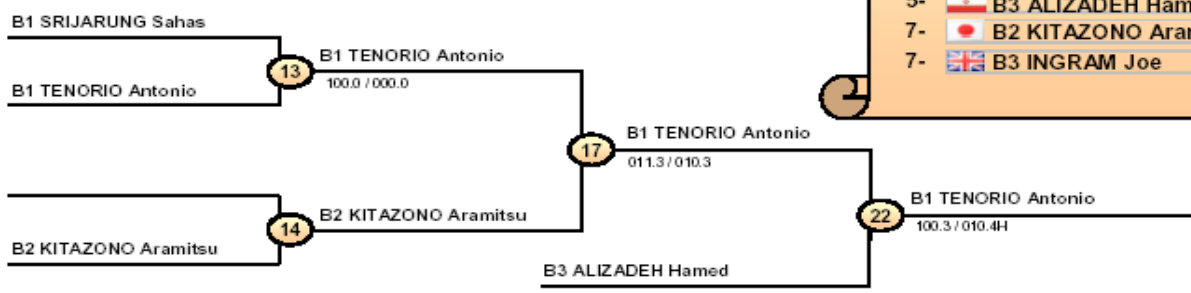

REPECHAGE B

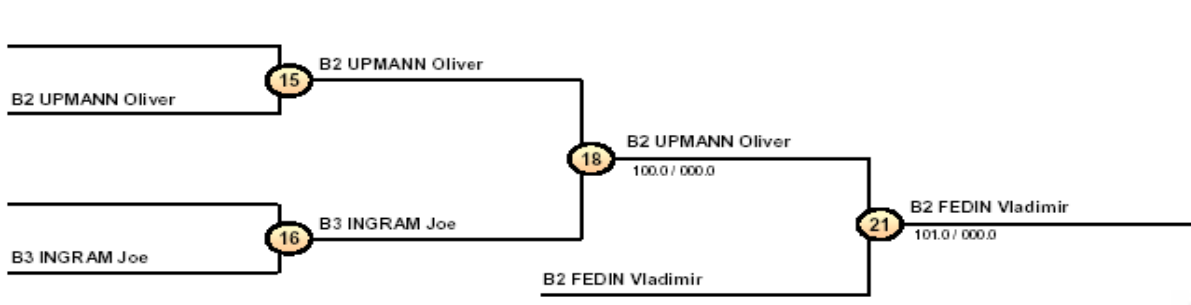



PARALYMPIC GAMES LONDON 2012

01/09/2012



M+100

Nb=12

A

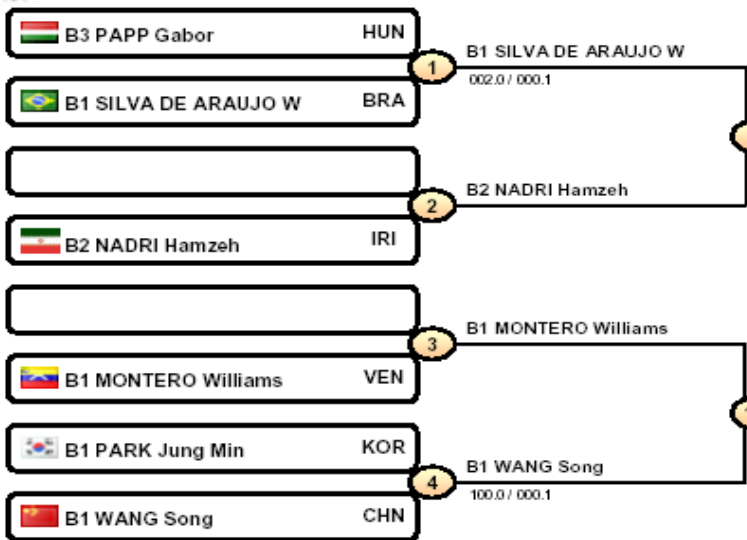

B

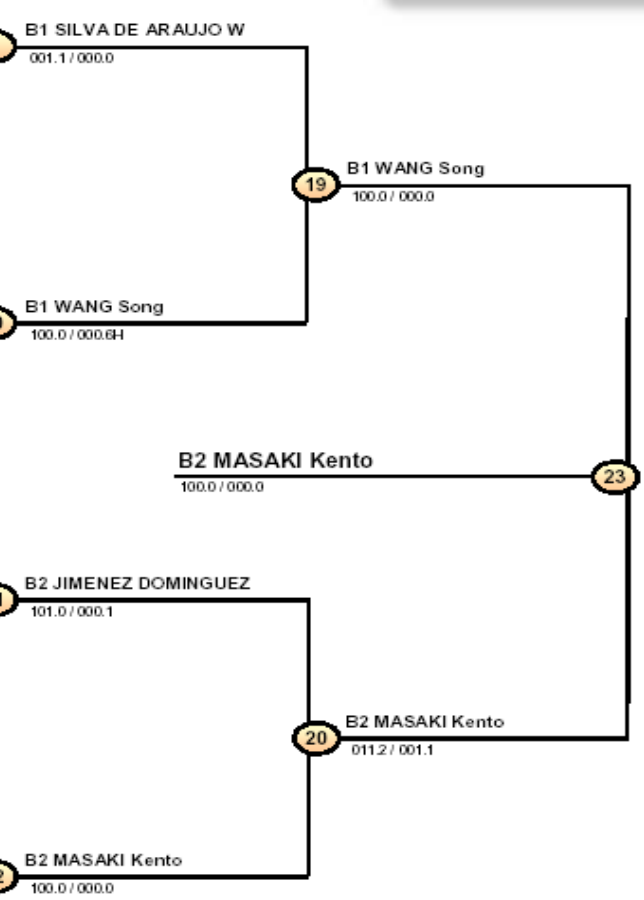
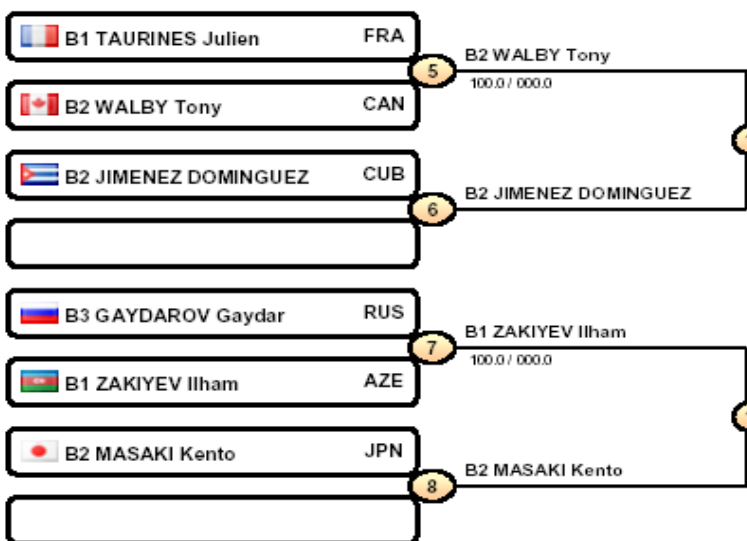

1-		B2 MASAKI Kento	JPN
2-		B1 WANG Song	CHN
3-		B1 ZAKIYEV Ilham	AZE
3-		B2 JIMENEZ DOMINGUEZ	CUB
5-		B1 SILVA DE ARAUJO W	BRA
5-		B2 NADRI Hamzeh	IRI
7-		B1 PARK Jung Min	KOR
7-		B2 WALBY Tony	CAN

REPECHAGE A

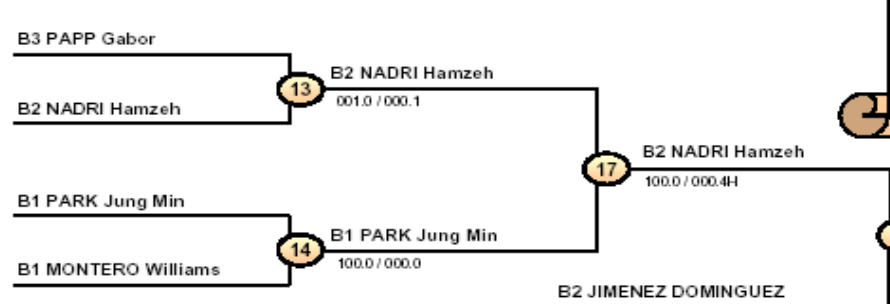

REPECHAGE B

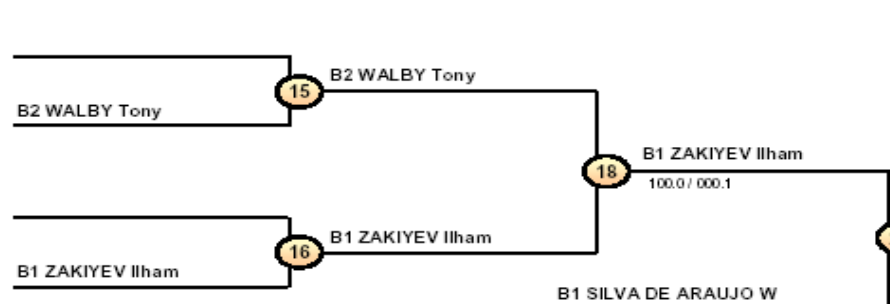



JUDO MEDAL TABLE

2012 LONDON PARALYMPIC GAMES

Rank	Country	 Gold	 Silver	 Bronze	 Total
1	 Ukraine	3	0	2	5
2	 Cuba	2	0	2	4
3	 Azerbaijan	2	0	1	3
3	 Germany	2	0	1	3
5	 People's Republic of China	1	5	1	7
6	 Spain	1	0	2	3
7	 Japan	1	0	0	1
7	 Republic of Korea	1	0	0	1
9	 Russian Federation	0	1	4	5
10	 Brazil	0	1	3	4
11	 Argentina	0	1	1	2
11	 Great Britain	0	1	1	2
11	 Turkey	0	1	1	2
11	 United States of America	0	1	1	2
15	 Taipei (Chinese Taipei)	0	1	0	1
15	 Uzbekistan	0	1	0	1
17	 Algeria	0	0	3	3
18	 Hungary	0	0	1	1
18	 Mexico	0	0	1	1
18	 Venezuela	0	0	1	1